

Produktinformation Product information

TUBEPOINT STABLEUCHE TUBULAR LIGHT

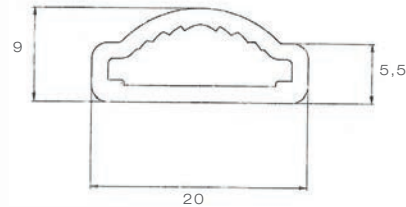

Abmessung Lichtscheibe
Dimension lens

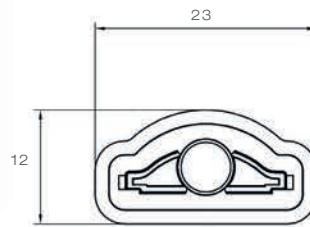

Abmessung Endkappe
Dimension endcap

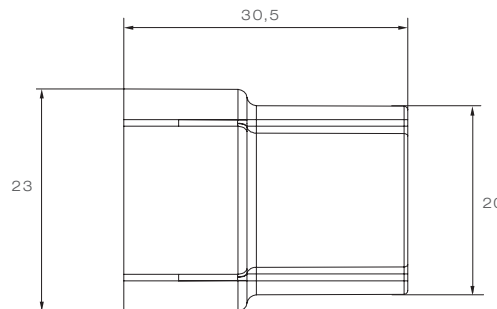

PRODUKTVORTEILE/NUTZEN

- schlankes Design
- gutes Preis / Leistungsverhältnis
- unterschiedliche Längen
- perfekte Lichtausbeute
- beliebig erweiterbar durch P&R / DC Verbinder
- nachträgliche Erweiterung jederzeit möglich
- einfache und unkomplizierte Installation

PRODUCT BENEFITS

- slim design
- unique price-performance ratio
- various length
- perfect light-output
- optional extendable with P&R and DC connectors
- subsequent assembly
- simple installation

TUBEPOINT

TECHNISCHE DATEN TECHNICAL FACTS			
	510 mm	960 mm	1.410 mm
LÄNGE DER LINSE: LENGTH OF LENS:	450 mm	900 mm	1.350 mm
NENNSPANNUNG: NOMINAL VOLTAGE:	12 V oder/or 24 V	12 V oder/or 24 V	12 V oder/or 24 V
LUMEN BEI NENNSPANNUNG: LUMEN AT NOMINAL VOLTAGE:	375 lm	750 lm	1125 lm
LEISTUNG: POWER:	4,5 W	9 W	13,5 W
ANSCHLUSS: CONNECTOR:	P&R oder/or DC	P&R oder/or DC	P&R oder/or DC
GEWICHT: WEIGHT:	0,1 kg	0,15 kg	0,2 kg
MATERIAL: MATERIAL:	PMMA		
TEMPERATURBEREICH: TEMPERATURE RANGE:	- 20°C~ + 50°C		
LICHTFARBE: LIGHT COLOUR:	5700 K		
IP-KLASSE: IP-RATING:	IP6K9K		
EMV-ABNAHME: EMC APPROVAL:	R10		

LICHTSTROM IN ABHÄNGIGKEIT DER VERSORGUNGSSPANNUNG LUMINOUS FLUX DEPENDING ON POWER SUPPLY

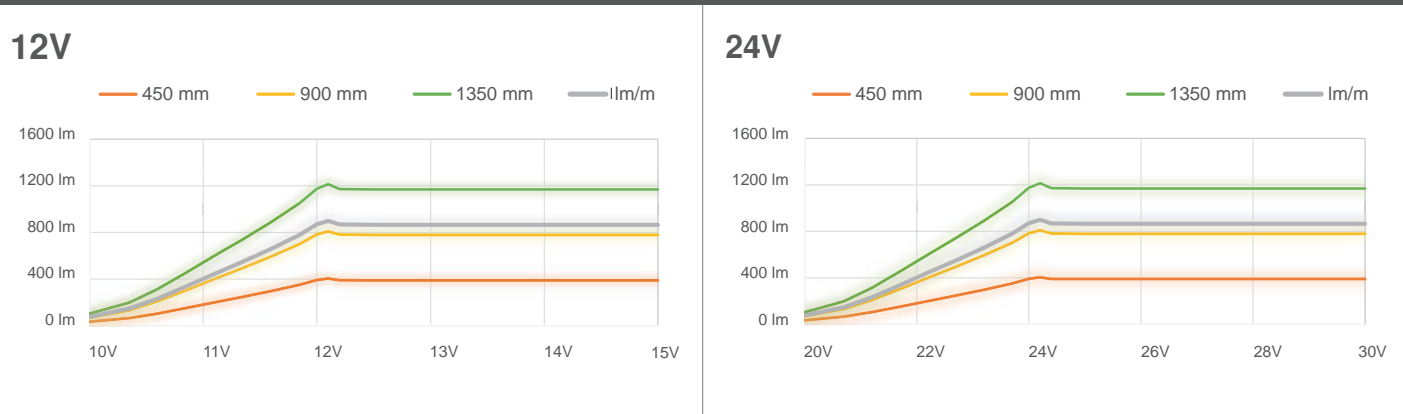

TUBEPOINT

HALTERUNGEN BRACKETS

PENDELHALTER: PENDULAR BRACKET:

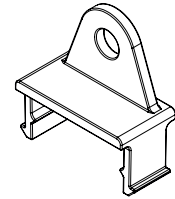
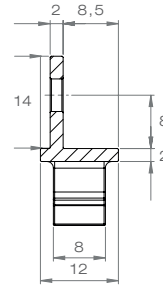
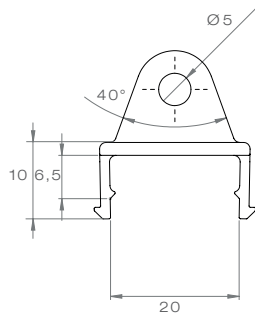

HALTER FÜR PROFIL: PROFILE BRACKET:

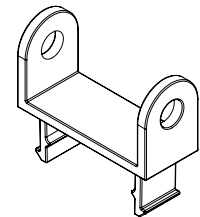
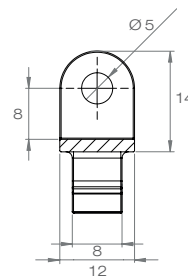
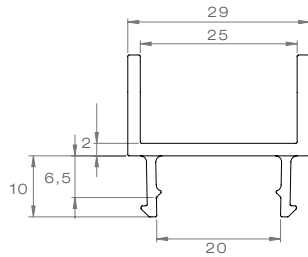



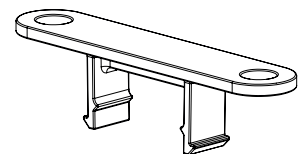
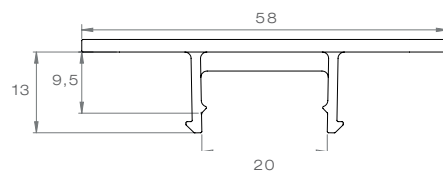

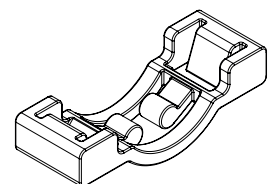
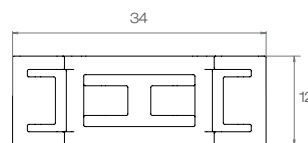
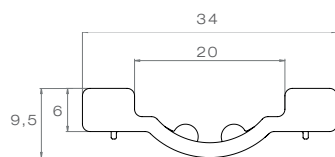

HALTER FÜR DIREKTANBAU: DIRECT MOUNTING BRACKET:



VERSCHLUSSKAPPE: FIXATION CLIP FOR BRACKET:



TUBEPOINT

BESCHREIBUNG / DESCRIPTION	OEM	AM
Tubepoint 450 mm mit 0,1 m Kabellänge Tubepoint 450 mm with 0.1 m cable length		
Tubepoint 450 mm, mit P&R Anschluss, 12V Tubepoint 450 mm, with P&R connector, 12V	21-8004-007	21-8004-001
Tubepoint 450 mm, mit P&R Anschluss, 24V Tubepoint 450 mm, with P&R connector, 24V	21-8004-017	21-8004-011
Tubepoint 450 mm, mit DC Anschluss, 12V Tubepoint 450 mm, with DC connector, 12V	21-8004-027	21-8004-021
Tubepoint 900 mm mit 0,1 m Kabellänge Tubepoint 900 mm with 0.1 m cable length		
Tubepoint 900 mm, mit P&R Anschluss, 12V Tubepoint 900 mm, with P&R connector, 12V	21-8004-037	21-8004-031
Tubepoint 900 mm, mit P&R Anschluss, 24V Tubepoint 900 mm, with P&R connector, 24V	21-8004-047	21-8004-041
Tubepoint 900 mm, mit DC Anschluss, 12V Tubepoint 900 mm, with DC connector, 12V	21-8004-057	21-8004-051
Tubepoint 1350 mm mit 0,1 m Kabellänge Tubepoint 1350 mm with 0.1 m cable length		
Tubepoint 1350 mm, mit P&R Anschluss, 12V Tubepoint 1350 mm, with P&R connector, 12V	21-8004-067	21-8004-061
Tubepoint 1350 mm, mit P&R Anschluss, 24V Tubepoint 1350 mm, with P&R connector, 24V	21-8004-077	21-8004-071
Tubepoint 1350 mm, mit DC Anschluss, 12V Tubepoint 1350 mm, with DC connector, 12V	21-8004-087	21-8004-081
Halterungen Brackets		
Pendelhalter pendular bracket		21-8007-107
Halter für Profil profile bracket		21-8007-117
Halter für Direktanbau direct mounting bracket		21-8007-127
Verschlusskappe fixation clip for bracket		21-8007-137
Set: Halterungen Kit: brackets		
5x Pendelhalter mit Verschlusskappe 5x pendular bracket with fixation clip		21-8007-144
5x Halter für Profil mit Verschlusskappe 5x profile bracket with fixation clip		21-8007-154
5x Halter für Direktanbau mit Verschlusskappe 5x direct mounting bracket with fixation clip		21-8007-164